



Shenzhen XinShengYang Opto-electronics Technology Co.,Ltd

LED BARN LIGHT SPECIFICATION (XSY-DD35W/50W)



LM80



ErP

IP65



Product Name	LED Barn Light
Model Number	XSY-DD
Version Number	A version
Valid From	2017 / 11 / 1

Dusk-to-dawn LED Outdoor Barn Light (Photocell Included)

Model No.: XSY-DD35W / XSY-DD50W

Power: 35W / 50W

Features

- Universal voltage AC120-277V 50/60Hz.
- 120lm/W for fixture.
- Using high quality SMD2835 chips.
- Constant current power supply.
- High Power Factor >0.9, Low THD Driver.
- Constructed from die-cast aluminium, with a PC cover, and rated at Ip65.
- Respirator design: Balance the different pressure between the atmosphere and the shell, it is water proof also defog and avoiding the drop condensation, extend the product lifespan.
- 5 years Warranty.
- Available with Photocell sensor.
- UL/DLC/ETL certificate.



Drawing

Unit:mm

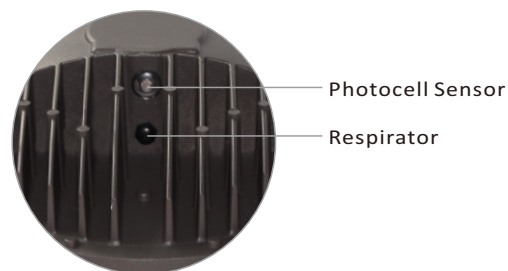
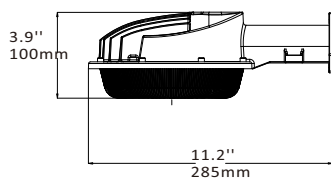
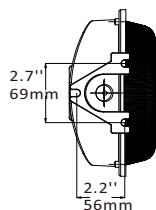
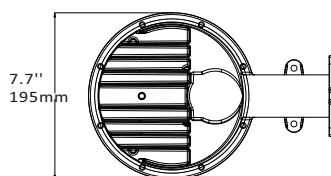

Application

Widely used in Shopping mall, hotel, shop, showroom, cafe, restaurant, garden, porch, etc.

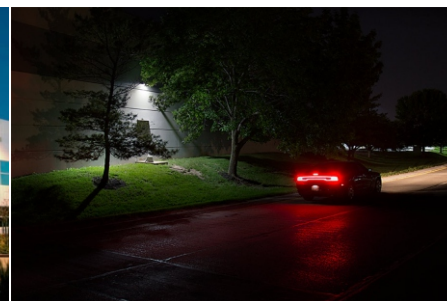

Parameters

Item	Model	XSY-DD35W	XSY-DD50W
General Performance	Power	35W	50W
	Lumen Output	4200lm	6000lm
	Efficacy	120lm/W	
	Color Temperature	3000K/4000K/5000K/5700K	
	LED type	SMD 2835	
	CRI	Ra>70	
	Power Factor	>0.9	
Electrical	Input Voilage	120-277VAC,50/60Hz	
	THD	<20%	
	Beam angle	120°	
	Weight	2.2Kg	2.5Kg
Physical	Dimension	285x195x100mm	
	Housing	Die-cast aluminum	
	Cover	PC	
	Mounting	Wall Mounting	
	Operation Temperature	-35°C~55°C	
	Finish	Brown	
	IP rated	IP65	
	Certificate	UL, DLC, ETL,CE, RoHS	
Certificate	Material Usage	E487752	
	Driver Class	Class II	
	LED Class	Rated to 50,000 hours	

Chip Temperature Test

Great heat dissipation performance, good for LED lifespan

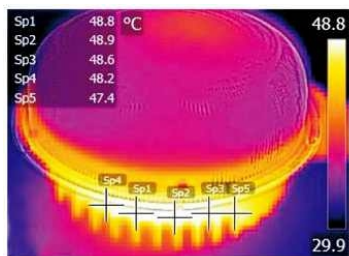

Distribution Curve

50W LED Yard Light

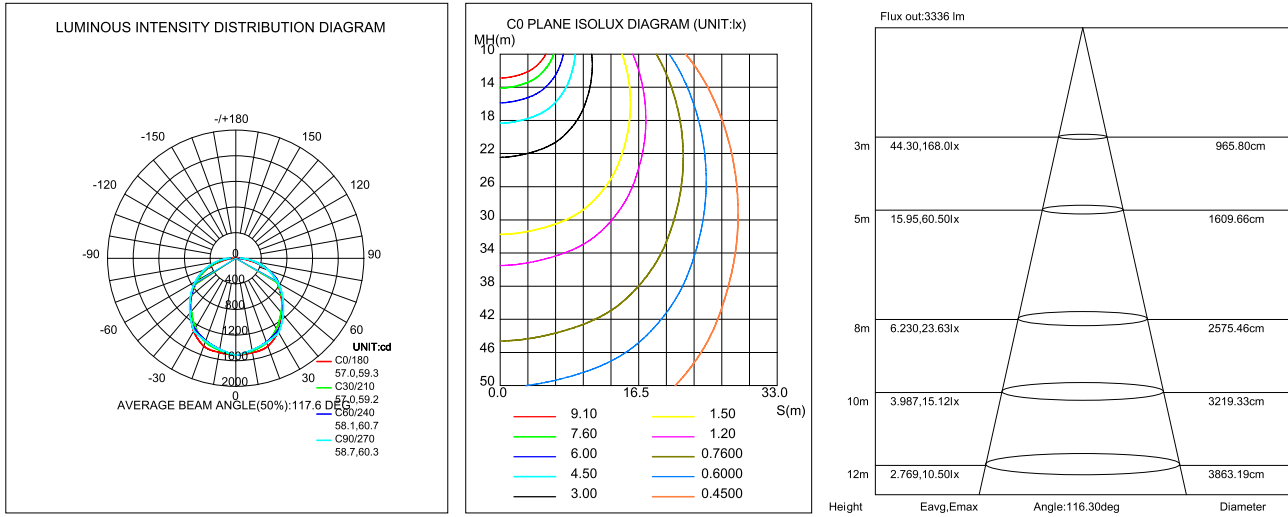

Installation Instruction

1. Dusk-to-dawn LED Outdoor Barn Light luminaire features a design that can be mounted to any vertical surface using lag bolts or other comparable and suitable anchors, with a wiring compartment that is easily accessible without the need to remove the lens or disassemble the fixture.
2. Dusk-to-dawn LED Outdoor Barn Light can also be mounted to existing 1-1/2" or 1-5/8" pipe mounts, offering the installer the flexibility to satisfy many different mounting applications and requirements.
3. This is especially useful when using the LED Outdoor Barn Light to retrofit older dusk-to dawn luminaires.

Wall Mounting

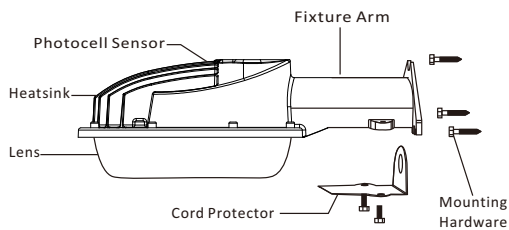

Arm Mounting

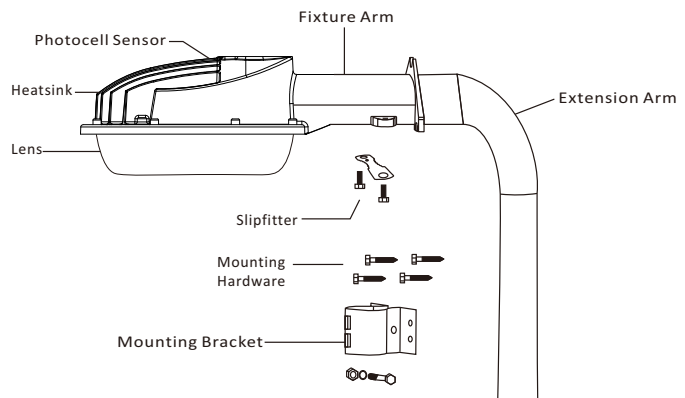

Packaging

Packaging: Wall Mounting

No.	Model	Power	N.W.	Inner Box	G.W	Qty/ctn	Outer Carton
1	XSY-DD35W	35W	1.4Kg	300x200x110mm	9.3Kg	6	410x310x350mm
2	XSY-DD50W	50W					

Packaging: Arm Mounting

No.	Model	Power	N.W.	Inner Box	G.W	Qty/ctn	Outer Carton
1	XSY-DD35W	35W	2.05Kg	300x200x110mm	5.1Kg	2	625x240x170mm
2	XSY-DD50W	50W	2.05Kg	300x200x110mm	5.1Kg	2	625x240x170mm

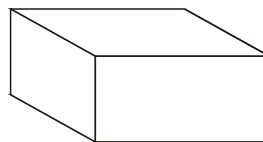
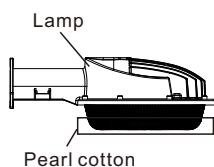

Packaging: Wall Mounting

Qty: 6PCS

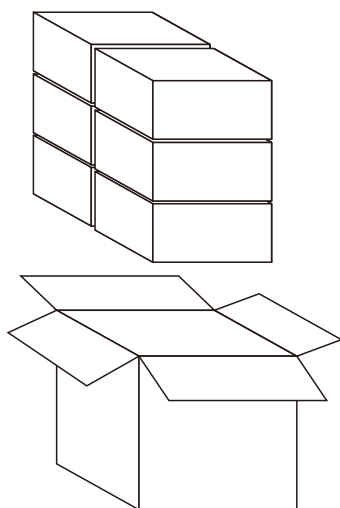

Packaging: Arm Mounting

Qty: 2CS

Extension Arm(2PCS)

